

HS-300B-HD-C Technical Data Sheet

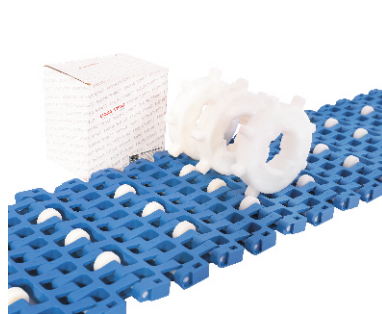
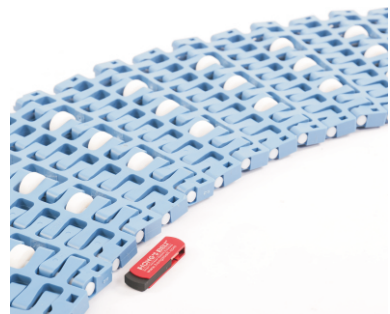
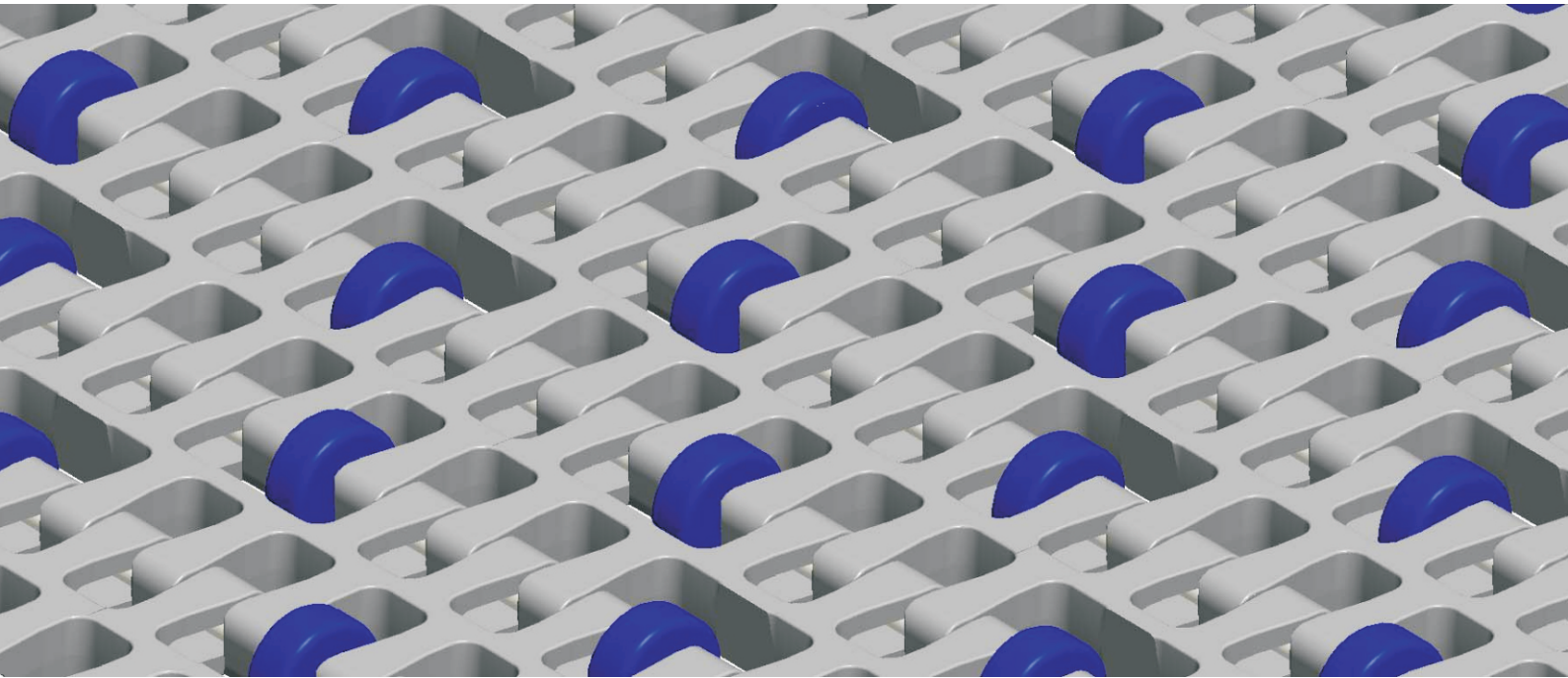

Pitch: 45mm Minimum Width: 218mm Open Area: 38% Permit: FDA Rod: Ø5.8mm Flight: No Side Guard: No Curve : Yes	
--	--

Data

Belt Material	Belt Strength				Temperature		Belt Weight (Kg/M ²)
	Straight		Curve		°C (min.)	°C (max.)	
	Kg/M(BW)	N/M(BW)	Kg/M(BW)	N/M(BW)			
Polypropylene	2060	20600	206	2060	1	100	7.1
Polyethylene	1460	14600	146	1460	-60	60	7.6
Acetal	3170	31700	317	3170	-40	80	10.5
Nylon	2050	20500	205	2050	1	180	9.7

BW- Belt Width

Color Table

Polypropylene					Polyethylene					Acetal					Nylon				
W	G	N	DB	B	W	G	N	DB	B	W	G	N	DB	B	W	G	N	DB	B
●	●						●			●				●				●	

W-White, G-Gray, N-Nature, DB-Dark brown, B-Blue

Friction Tables

Belt Material	Friction Wearstrips & Products							
	UHMW	HDPE	Steel	Glass	SUS	Plastic	Cardboard	Aluminum
Polypropylene	0.32	0.24	0.15	0.09	0.13	0.08	0.15	0.25
Polyethylene	0.13	0.11	0.26	0.19	0.31	0.16	0.21	0.41
Acetal	0.11	0.09	0.27	0.16	0.26	0.15	0.19	0.28
Nylon	0.18	0.13	0.25	0.16	0.26	0.16	0.19	0.27

SUS - Stainless Steel

Equivalent type with other Brand

Brand Name	Intralox	UNI	Rexnord	MCC	Habasit	KVP
Series & Type	2200	Flex-SNB	1200		2500	610
			7956		3800	

The above content is only for reference.

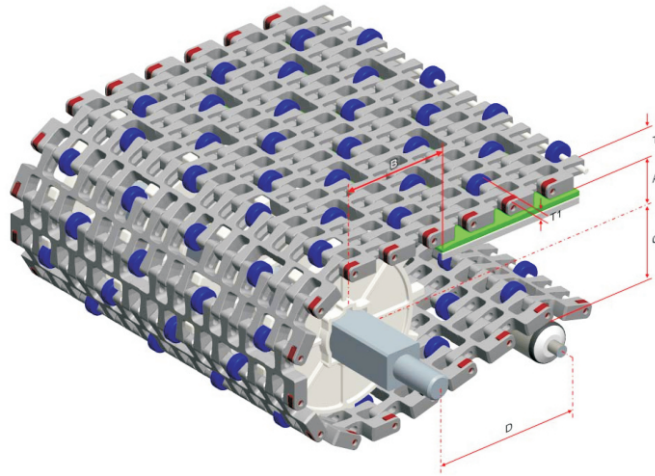

Conveyor Frame Dimensions

Unit : mm

No. Teeth	A (Min.)	B (Min.)	C (Max.)	D (Min.)	T	T1
8	52.5	70	49	250	15	4.5
12	84.7	102.2	81.2	250		

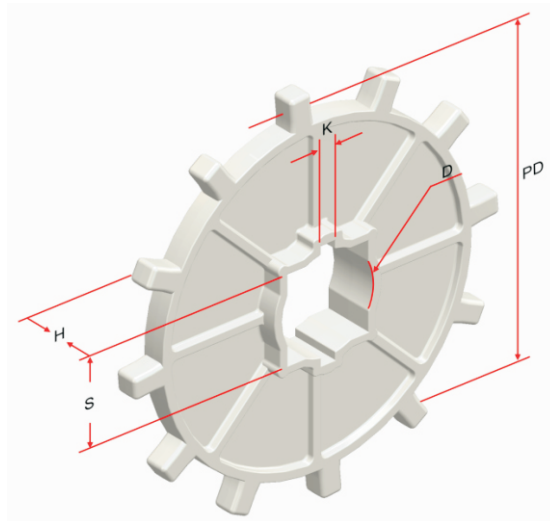

Sprocket Dimensions

Unit: mm

No. Teeth	PD	S	D	H	K
8	120	38.5/40.5	25.2/25.5/38.1	25	6.35X3.17
12	184.5	38.5/40.5	30.5/46.5	24	8X8

Design Guide Summary

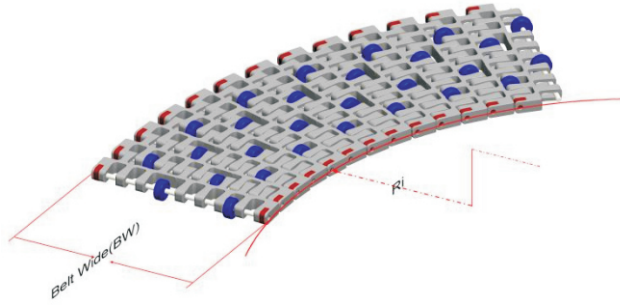

- ⌘ The minimum turning radius (inside) is 2.2 times of belt width under all feasible belt Width, 2.5 times of belt width is the most optimal.
- ⌘ The minimum straight run section near driving shaft and idling shaft of Radius belt must be 2 times of the belt width in length.
- ⌘ The minimum straight run section between two turns of opposing direction must be 2 times of the belt width in Length.

Guide Rail & Wear Strips

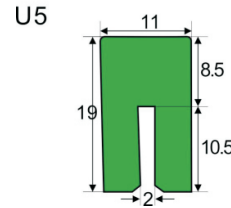
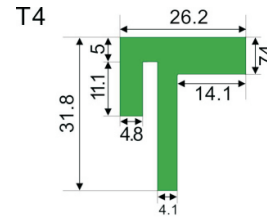
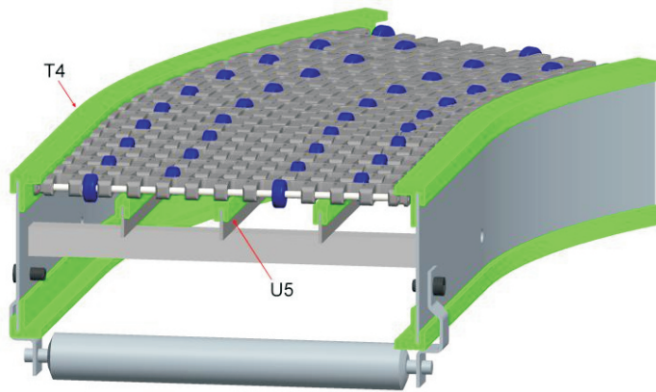

- ⌘ We have different kinds of guide rail and wear strips for your choice; For more information, please consult our sales team.

Support Mode of Insert Roller

⌘ **Accumulation**

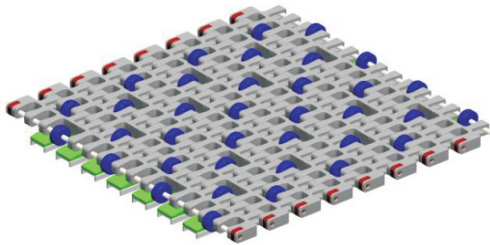

Wear Strips are placed between rollers for accumulation.

⌘ **Multi-Speed**

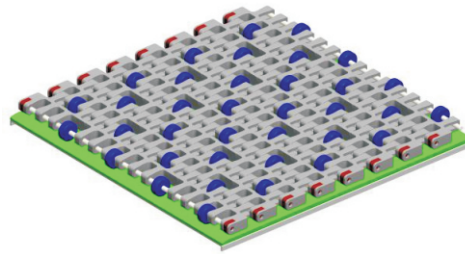

Wear Strips are placed under the rollers and the speed of products on the belt will be 2 times of the belt speed.